

1 ZÖLLNER Signal Automaton 5+S - flush type

approval No. BSH/49/28 P/01/92 - for all ship classes
design to drawing SP 4943-4
Ident No. 01.44943
operating on 24 V DC, 110 or 230 V AC 1phase
design with black front plate 144 x 96 mm acc. to DIN 43700
allowing to give five different signals in accordance
with Rule 35 (a, b, c, e, g) of the Colregs 1972
including general emergency alarm connection
according to SOLAS Chapter III, Part C, Reg. 50
comprising:

- 5 illuminated keys:
 - a) manual sound signals
 - b) parallel switching of sound and light signals
 - c) light signals
 - d) Automaton "ON"
 - e) Automaton "OFF"

- 3 selector switches:
 - a) for signal preselection of 5 fog signals
 - b) for adjustment of interval duration of 60 sec. to 120 sec.
 - c) for whistle preselection (the internal circuit will be made in accordance with the customer provided data and number of whistles)

- 1 dimmer for illumination of keys
with terminal block to connect:
 - 2 signal horns
 - 1 maneuver signal lamp
 - 1 push-button key for sound signals
 - 1 push-button key for light signals
- 3 potential-free connections for 2 horns and
1 maneuver signal lamp
- 1 connection for general alarm automaton
(ZÖLLNER type GAV)

approx. net weight 0.9 kg

1 Set of Spare Parts for Signal Automaton 5+S

Ident No. 00.PSLi 146



Signal Automat 5+S für akustische und optische Signale
Signal Automaton 5+S for sound and light signals

TYP „C“ Schiff mit 2 Pfeifen, Abstand $\leq 100m$, Ship with 2 whistles, distance $\leq 100m$

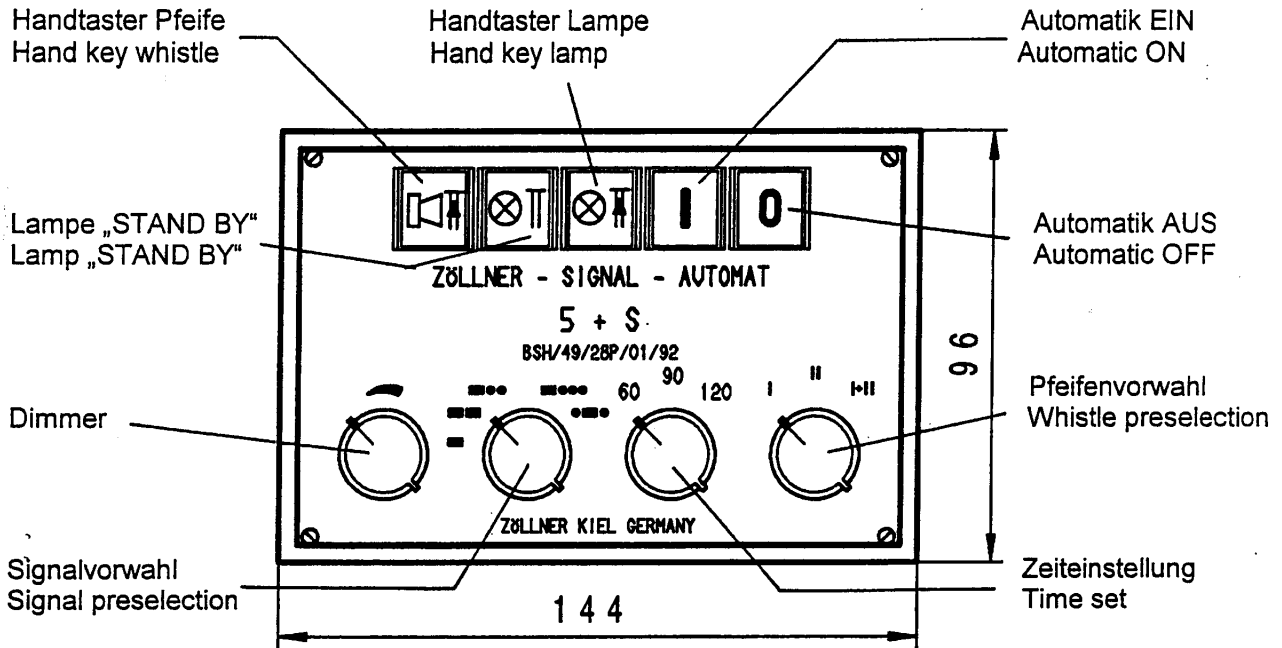

Einbauöffnung: 139x92mm
Hole for installation: 139x92mm

Einbautiefe: 100mm
Plug in depth: 100mm

TYP „B“ Schiff mit 2 Pfeifen, Abstand $> 100m$
TYP „B“ Ship with 2 whistles, distance $> 100m$

TYP „A“ Schiff mit 1 Pfeife
TYP „A“ Ship with 1 whistle

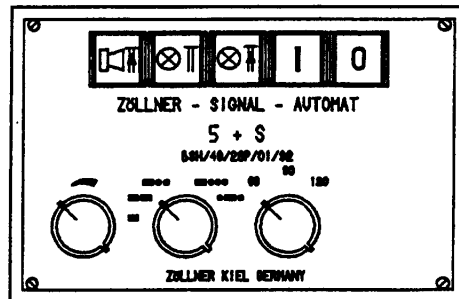
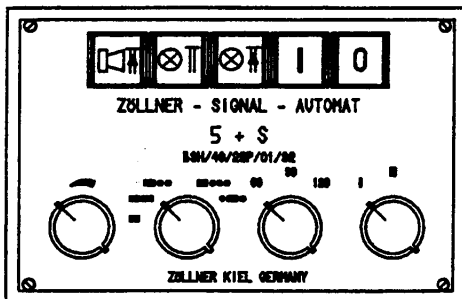

s. Anschlussplan / I. Connection diagram
01.16280 -4

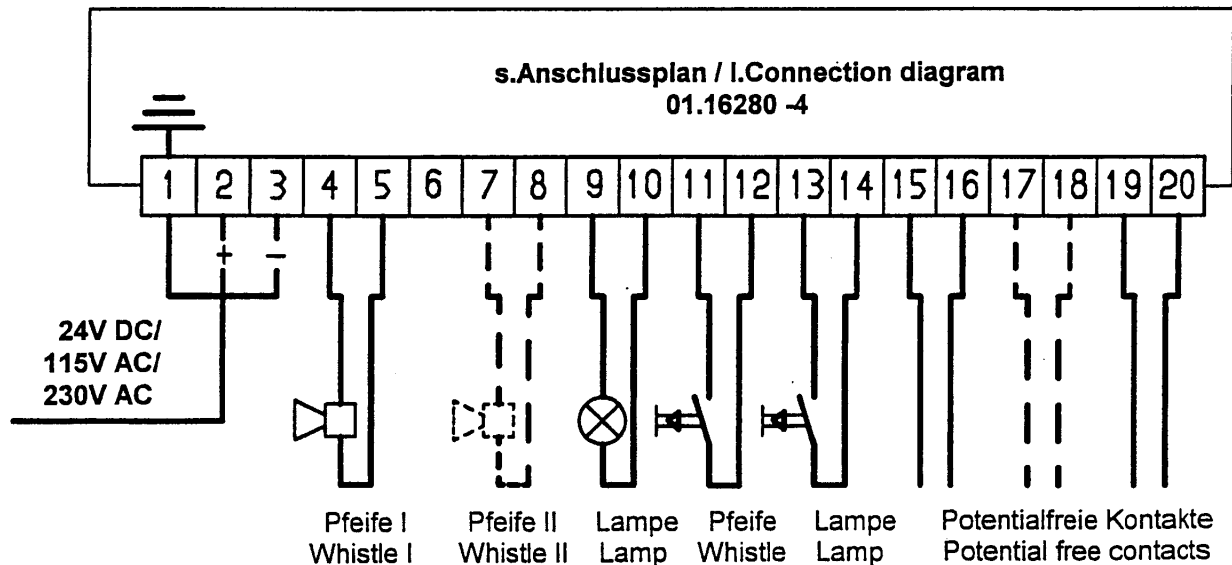

Änderung vorbehalten!
Subject to alteration!



Schaltplan Signal-Automat

Wiring diagram Signal Automaton

5 + 8

Typ A = Pfeife I/Whistle I
 Typ B = Pfeife I oder II/Whistle I or II
 Typ C = Pfeife I, I+II, II/Whistle I, I+II, II

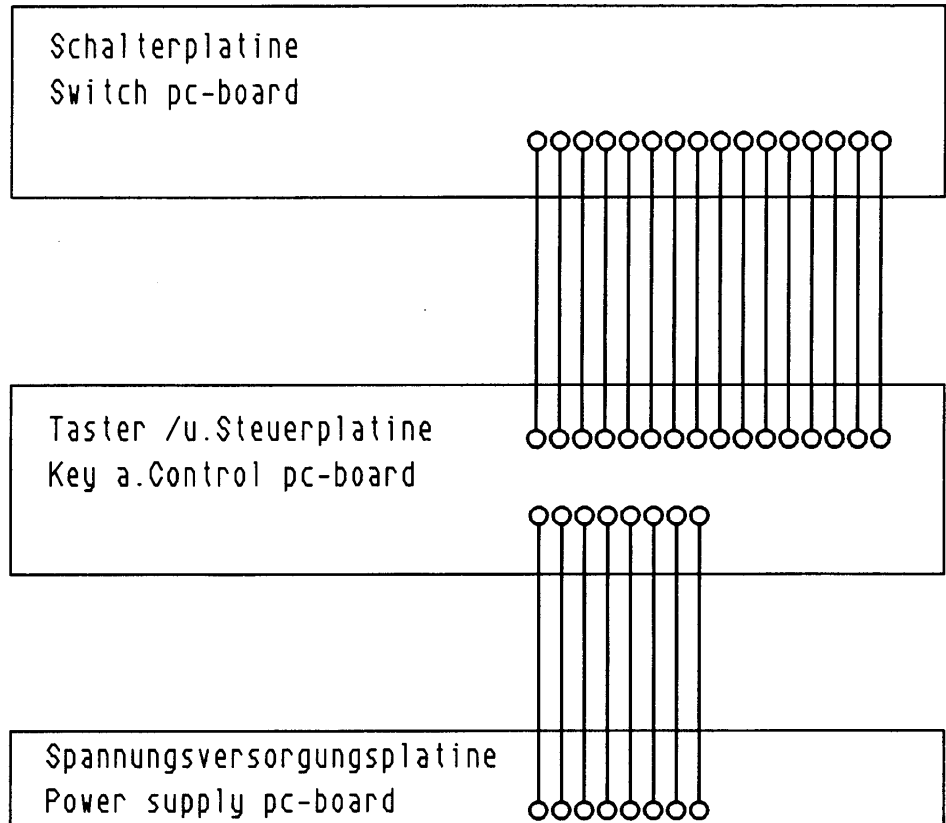

F1, F2=2A

s. Typenschild
I. at type plate

Einspeisung
Feeding

24V DC or
110-120V AC or
210-240V AC

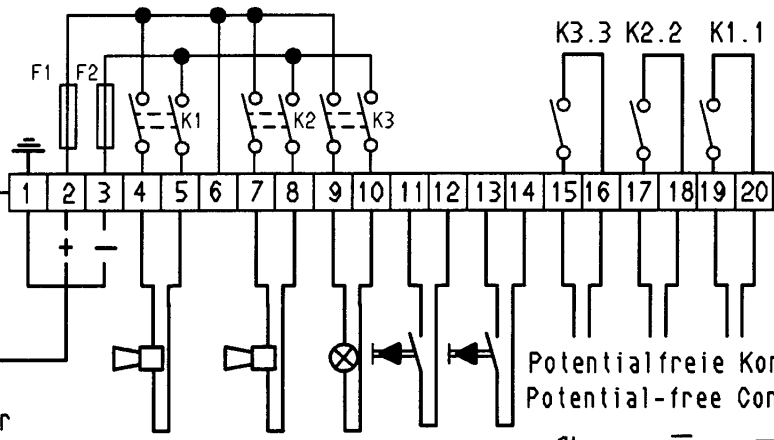

Potentialfreie Kontakte
Potential-free Contacts

Pfeife I Whistle I
 Pfeife II Whistle II
 Lampe Lamp
 Pfeife Whistle
 Lampe Lamp
 Lampe Lamp
 Pfeife II Whistle II
 Pfeife I Whistle I

Makrofon
m. Heizung/w. heating

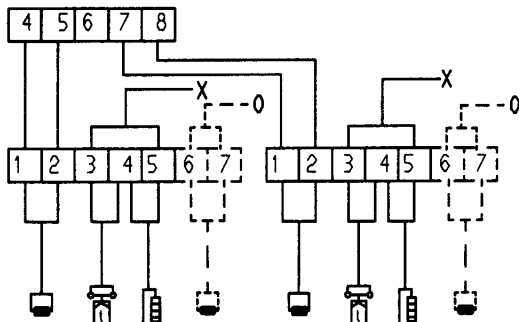

Pfeife I Whistle I
 Pfeife II Whistle II

X = Heizspannung/heating tension
 0 = Notstrom/emergency tension

- Pfeife I/whistle I=Zet-Horn/Makrofon
- Pfeife II/whistle II=Zet-Horn/Makrofon
- Pfeife I/whistle I=ZETFON/Drucker, printer
- Pfeife II/whistle II=ZETFON/Drucker, printer
- Anschluss /connection=General Alarm (Zöllner GAV)

Tasterleitungen verdreht oder abgeschirmt verlegen !
 Lay cables for signal keys twisted or screened !

Werkseitig eingestellt
 Factory adjusted

Typ A , B , C

Änderung vorbehalten !
Subject to alteration !

16.7.96 Sbg
17.01.97 Sch.

ZÖLLNER • KIEL

01.16280 -4



Ersatzteilsatz für Automat
Set of spare parts for Automaton

5+S

Li
146

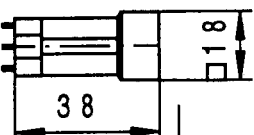
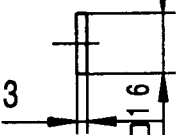
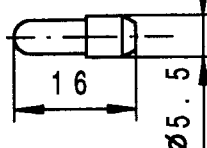
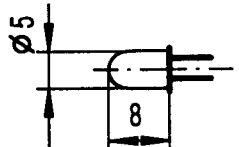
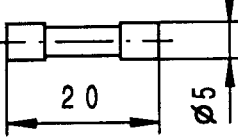
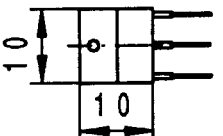
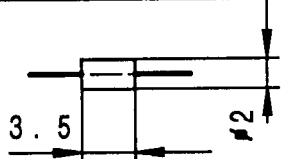
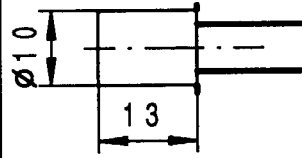
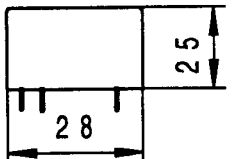
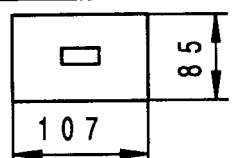
Stck. Qty.	Zeichnung Drawing	Benennung/techn.Daten Designation/techn.Data	Teil Nr. Part no.	Bestell-Nr. Order no.	Gewicht Weight kg
1		Leuchttaster illuminated key #16,2x18x18	Li146-10	6109514550	0,700
2		Tasterkappe cap of key grün/green	Li146-11	6109519535	0,002
2		Stecklampe bulb 24V / 0,96W	Li146-20	6109319632	0,001
1		LED #5 rot/red	Li146-30	640115748	0,001
2		Sicherung fuse 2A #5x20	Li146-40	683320120	0,001
1		Spannungsregler voltage regulator +5V/1,5A	Li146-50	643010340	0,020
2		Diode diode 1N 4936	Li146-60	640414936	0,001
1		Quarz quarz 4,000 MHz	Li146-70	645706401	0,002
1		Relais relay 24V DC/5A	Li146-80	63252303705	0,018
1		Ersatzteilkasten spare parts box 107x85x47	Li146-90	887002010	0,065

Anderung vorbehalten!
Subject to alteration!

22.09.99 Sch.
22.06.95 Sch.

ZÖLLNER • KIEL